

2010

Playhouse Plans  
Step By Step Instructions

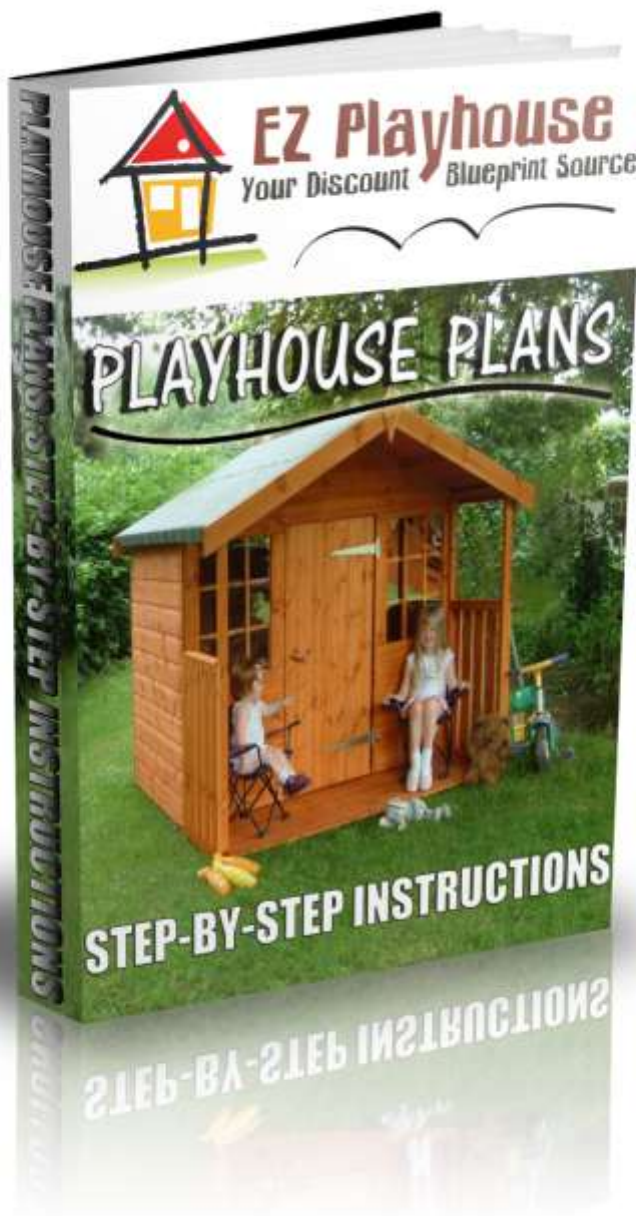

<http://EZPlayhouse.com>

Copyright

2010



**DISCLAIMER:**

READ BEFORE YOU BEGIN! THESE PLANS ARE INTENDED AS A GUIDE ONLY! READ THESE INSTRUCTIONS COMPLETELY THROUGH ONCE AND UNDERSTAND WHAT IS REQUIRED.

We will not be held responsible for any accidents or injuries anyone may sustain. Builder assumes all risks associated with construction work!

We assume some builder competency in the use of tools, safety and equipment.

If you are unsure of any procedures, please contact a professional. The methods in this plan assume a minimum amount of power tools.

Using other tools to speed the work process is just fine.

Work safely and wear proper safety equipment such as gloves, ear protection and eye protection.

## Foundation

The first thing anyone will ever before building a playhouse is a solid foundation. The foundation will help lift the playhouse off of the ground, prevent water intrusion, and gave the playhouse a nice aesthetic look.

It is up to the builder as to what type of foundation to lay down, but we will offer several varieties that will work nicely.

The first is by far the simplest foundation. It is simply a couple of 4x4 treated posts that will “sit” under the flooring of the playhouse.

The pros and cons of this type of construction are listed below the diagram.



Pros: This type of construction makes the playhouse mobile. If you intend on being able to drag it around. I would suggest some heavy-duty lock casters.

Easy to assemble. Simply follow the diagram above for the length of your cuts and assemble with 5" lag screws. Countersink the heads of the lag screws (we recommend at least 3/8Φ lag screws) so the heads will not impede the placement of the base planks.

Cons: Wooden. Even with the best maintenance, wood sitting directly on the ground is going to go bad eventually. You will need to put a coat of water-proofer around the base at least once a year.

Stability. We recommend anchoring the playhouse to a finite position, especially if you live in a high-wind area where the wind may be able to blow the structure over. Plus, a concrete foundation will give a flat, smooth surface to work upon.



The second type of foundation is the concrete foundation. These foundations generally take more time to complete, but they offer many advantages over a wooden foundation.

- 1) They are solid in the ground
- 2) They offer a flat level work area
- 3) They do not require maintenance

The easiest type of foundation we would recommend is the slab foundation. This type of foundation offers good water drainage and will last longer than the playhouse itself.

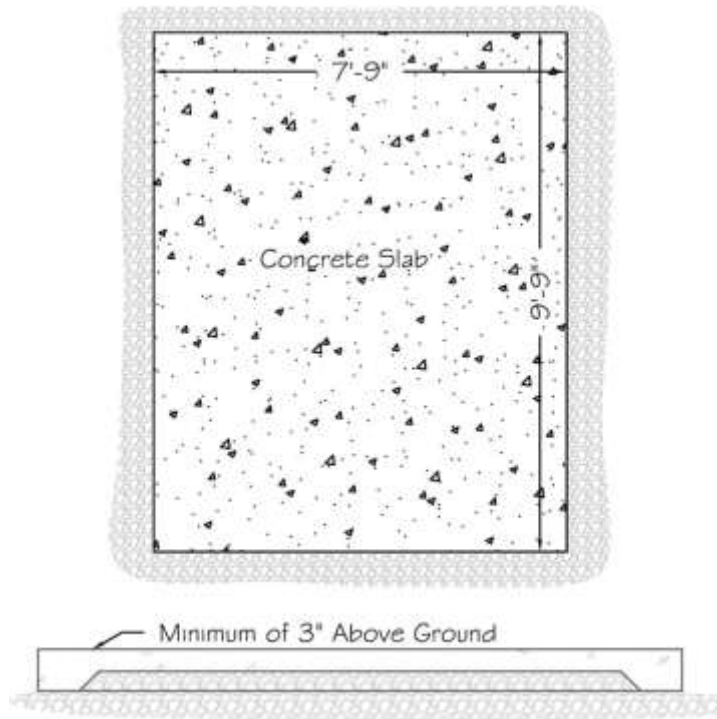

The easiest way to pour a concrete slab is to dig a trench the width of the shovel blade and about 2" deep.

- 1) Start by laying out where you want the playhouse to go.
- 2) Build a frame out of 2x6 based on the internal dimensions above. Remember, they are INTERNAL dimensions, not external. If you want external dimensions, add 3" to the overall length and width of the concrete slab and those will be the external dimensions with the concrete PLUS the 2x6 frame.
- 3) Pour some (preferably washed)  $\frac{3}{4}$  -1" peat gravel into the trench (to aid in water drainage).
- 4) Place the concrete frame in the trench and tap or add gravel where necessary to get the frame level. Make sure you level the length, width, and diagonally across the corners of the frame!
- 5) Once the concrete frame is level, continue to pour only about 1" of peat gravel into the frame and smooth out with a shovel or rake. Make sure you have at least 3" of frame above ground level!

- 6) Pour quick drying concrete into the concrete frame and use a board or concrete level to smooth the top. Don't forget to tamp the concrete to ensure there aren't any air pockets! Fill the frame level with the top and let dry.
- 7) When you are done and the concrete is dry, take the concrete form apart and fill in any remaining gaps in the trench with topsoil and grass. Tamp around the concrete slab to get a good seal.

The finished slab should look something like a diagram below. Hint: You can also follow the same instructions or use this slab for a shed, a gazebo, almost any small structure!



Congratulations! You now have a solid, long-lasting foundation to use for the playhouse!

## Framing

Before beginning any construction, please ensure you have all the necessary safety equipment you will need. Always read and understand what the instructions are telling you to do BEFORE attempting any cutting. Make sure all measurements are precise (within 1/16"). And any miter angles match the opposing angle shown.

- 1) To begin, you will need two 10' and 8' 2x6 planks (see Materials) and nine 8'-0" 2x4 planks.

Measure and cut the planks to the dimensions as shown below. Remember: Always check the actual length of boards. Some lumber manufacturers cut boards to length, some cut their board a little longer!

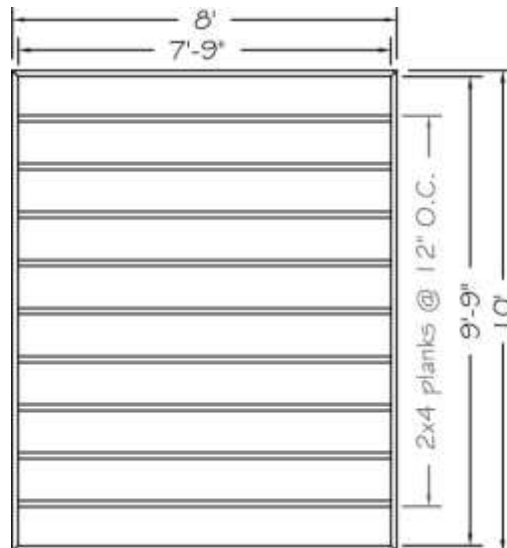

You should recognize the internal dimensions as the same as the concrete slab you just poured or the wooden foundation constructed.

Hint: For aesthetic reasons, we recommend mitering the 2x6 rim plank ends at 45<sup>0</sup>, it will create a nice, single seam. This is, however, NOT necessary!

- 2) Construct the rim of the flooring with 2x6s and the internal supports with 2x4s. Make sure the 2x4s are flush with bottom of the 2x6 frame! Assemble with nails or screws.

Hint: These plans are designed to be very solid and structurally sound. However, should budgetary constraints exist, the floor supports may be reduced to 16" O.C. (On Center). We recommend 12" centers, especially if you have a wooden foundation. 16" centers will work just fine if you have a concrete foundation.

- 3) Once the frame is complete and the 2x4s are flush with the bottom of the 2x6 rim, flip the entire floor over and you should be able to "sit" the flooring on top of the concrete (or wood) with a nice lip holding it tightly.
- 4) Use a rubber mallet or dead-blow hammer to tap the frame tightly onto the foundation.

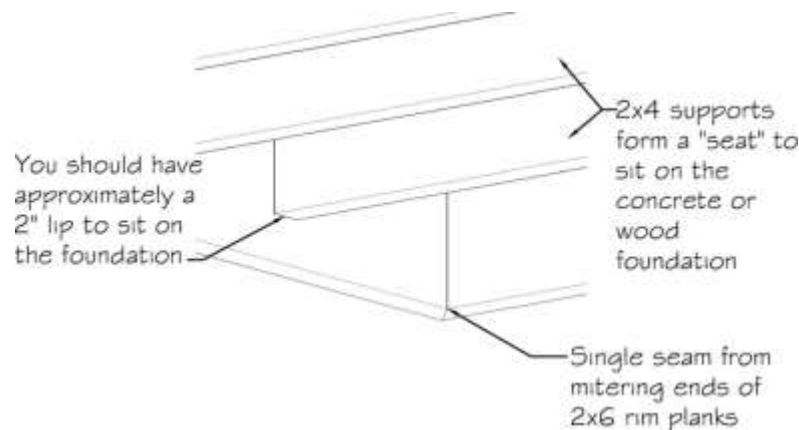



## Materials

Description:	Qty:
2x6x10' planks	2
2x6x8' planks	2
2x4x8' planks	9

For the flooring, we would recommend you spend a little extra and purchase some nice ¾ " cedar or oak plywood, or if you are planning on using carpet, ¾ " pine plywood will do just fine. Either way, we recommend using moisture barrier on the floor before laying the plywood flooring to prevent moisture from rotting the sheeting out from the bottom. Oak and Cedar have a much higher moisture tolerance than pine. We are assuming the playhouse is NOT going to be carpeted and will therefore continue as though hardwood flooring will be used. The principle is the same either way.

- 1) To begin, since the sub-floor should be 8'x10', you should be able to place two full 4'x8' plywood sheets right on top of the sub-floor and tack in place. Make absolutely sure the corners are flush and square or you will risk having to either rip one of the plywood sheets or pull up the flooring and try again!

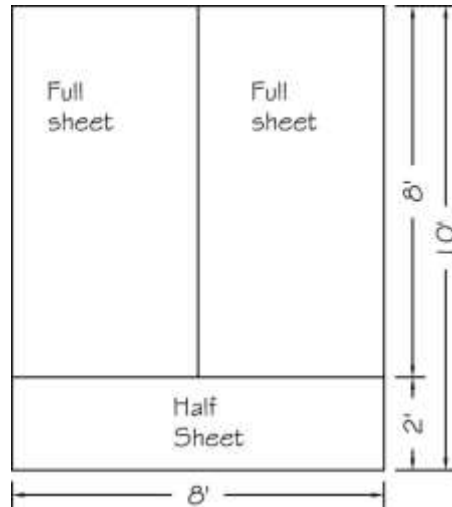

As shown from the diagram above, you will have to rip one sheet of plywood down the center. The easiest way to do this is to measure out 2' down the length of the plywood sheet and use either a table or circular saw to rip sheet to it's proper dimensions. Hint: This goes WAY smoother with a snap line (aka chalk line).



You should now have a nice platform with which to begin constructing the walls! Make sure the sheets are nice and level and the edges are square and flush. This will help around the time you begin the exterior sheeting.

Now we are going to begin working on the deck before we get too far ahead of ourselves. The deck will be a 8'x4' covered deck once you are done with the playhouse.

As with most actual houses, the deck will be a free standing deck just attached to the playhouse with nails.

We are going to make the deck a flush with the flooring so there is a smooth transition and nothing to step over.

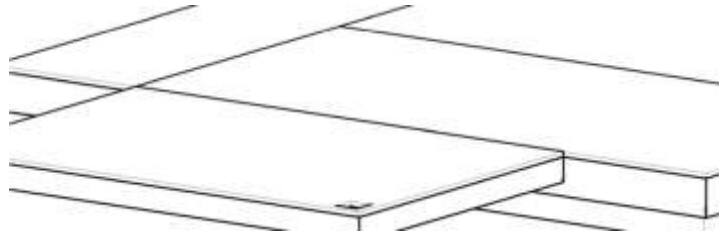

We are going to outline the steps for creating a 4'x6' deck on the front of the playhouse. For these plans, this deck is necessary to support the dormer that will cover the deck.

- 2) Begin by laying the deck as shown below with 2x4 planks. If you wish to use 2x6 planks, that will be fine, but the span is not wide enough to merit the use of 2x6 planks. Miter the end as shown for a single seam finish.

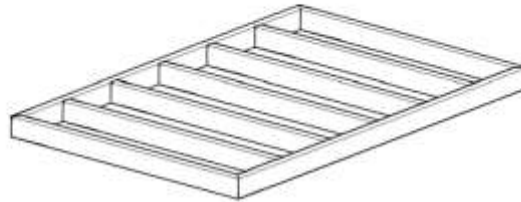
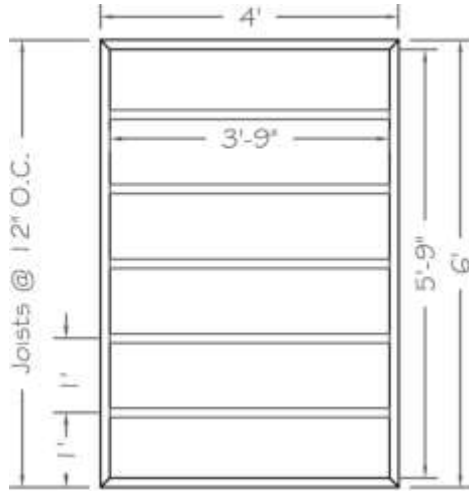

### Materials

Description:	Qty:
4'x8' Plywood sheeting	3
2'x4'x6'	2
2'x4'x4'	7

- 1) Mark the centerline of the deck planks and the centerline of the platform sheeting. Match both of the centerlines to center the deck on the bottom of the platform sheeting.

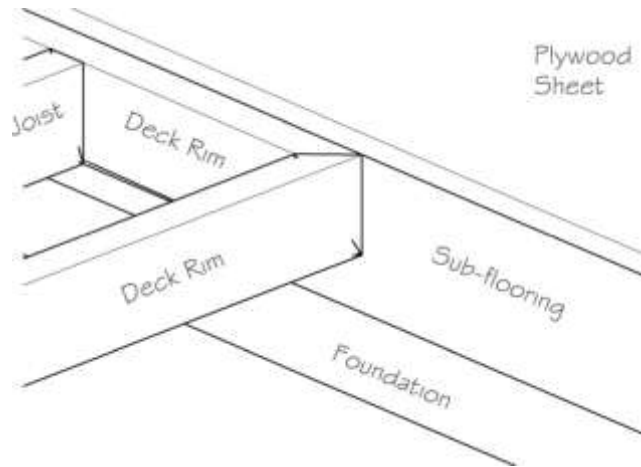

Hint: Notice the deck is flush with the bottom of the plywood sheeting. This is to make a nice, smooth surface to build on. You won't have to worry about stepping over the framework for the door or the front wall.

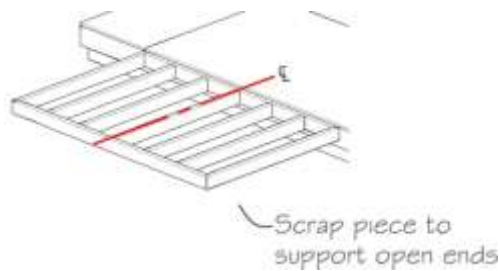

- 2) Use scrap pieces to support the open end of the deck. We will replace them with actual posts, so only tack the ends for support.
- 3) With assistance attach the deck rim to the platform sub-flooring. If you leveled correctly, you should be able to use the bottom of the platform sheeting as a guide to ensure the rim is level with the sheeting.



Hint: Notice the scraps are little offset from the edge, this is so you are free to align the posts in the next step without having to remove the temporary supports.

- 4) You will want to add some nailers to the inside edges of the post. These are easy to construct, simply follow the diagram below.

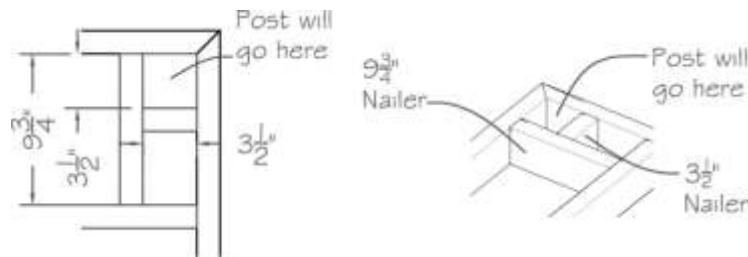

- 5) The last thing you will want to do before you put the post in place is cut and place the decking sheeting (unless you feel you want to lift the sheeting 10' and slide it down the posts). Cut a sheet  $\frac{3}{4}$  " cedar or oak plywood (yes, it should be cedar or oak as it will be open to the elements) as shown below.

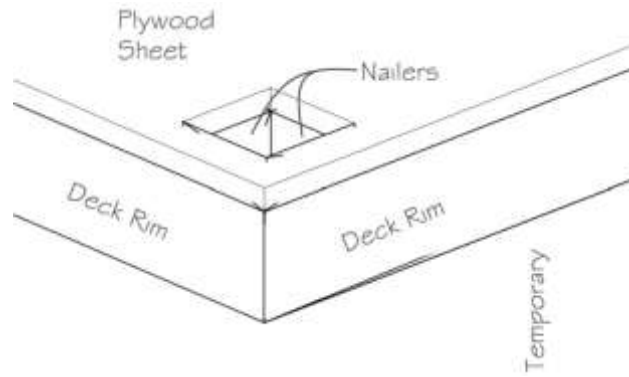
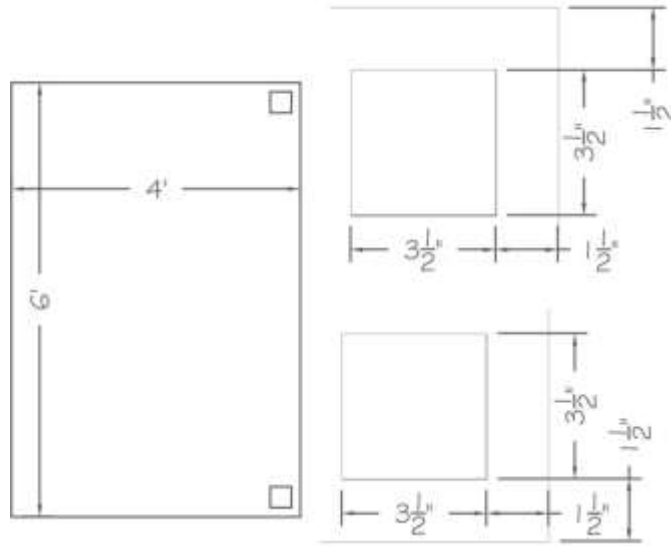

Materials

Description:	Qty:
4'x8'x3/4" Cedar or Oak Plywood	1
2'x4'x1' Nailers	4

6) Alright, time to see if this works. You should be able to slide a 4x4 post right down into the holes in the decking.

Leave the scrap pieces attached to take the weight of the deck for now.

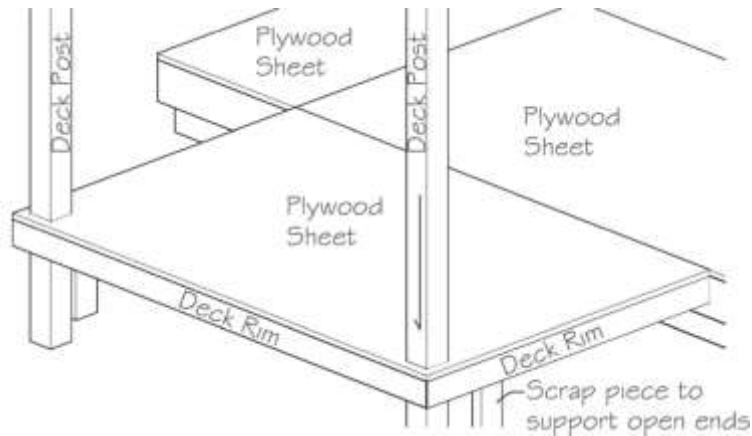

Hint: You may also dig a post hole and place the post into the hole to solidify the placement of the deck.

1) Dig your post hole directly under the corner of the deck rim. Make the hole at least 12" deep. We are using a 10' post to accommodate any variation in height anyway. 2) Once you have dug, have an assistant hold the post right in the corner of the deck rim while you tamp the post into the place. 3) Fill any gap around the post and use a tamping bar to solidify post in place. Follow step 4) to continue.

- 7) Once you have the post anchored where you want it, with assistance, have your helper shimmy the deck up and down slightly until the deck is level on both sides and diagonally on the deck.
- 8) Once the deck is level, quickly nail or screw the rim to the post. If you wish, it is a good idea to go under the deck and attach the post, through the nailers, with a couple of 3/8"x3" lag screws.



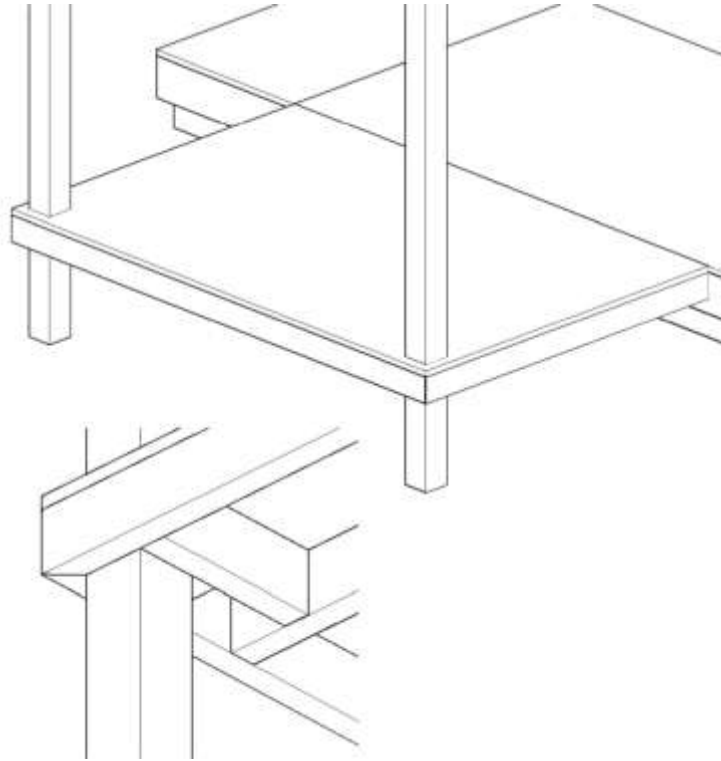

Up to this point you should have a structure similar to the image below.



Ok, you have the deck completed and you have a nice, strong foundation for the playhouse. On the next page, we will start detailing the wall structures.

## Materials

Description:	Qty:
4'x4'x10' Post	2

Now, we are getting to the wall structures. Some things to remember:

- 1) Always measure openings and cuts carefully!
- 2) Give yourself a small amount of rough opening space if you intend on purchasing windows and doors. We would recommend purchasing windows and doors prior to building wall structures so you may measure accurate rough openings. This set of plans will assist you in building some general doors and windows, but you may feel free to purchase doors or windows at your discretion. PLANS MAY NEED TO BE ALTERED!
- 3) These plans are to be intended as a guide ONLY! Should you choose to alter these plans at any time, remember to adjust measurements accordingly!

Now, time to start on the walls.

- 1) Start by cutting the entrance wall as shown below. Cut lengths carefully and make sure edges are flush and corners are square.

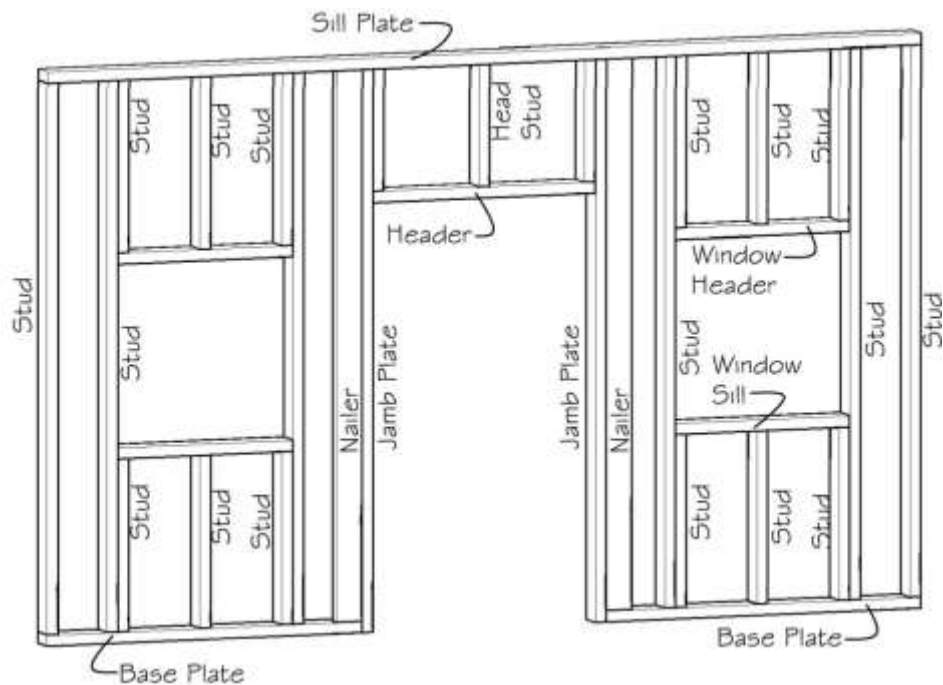
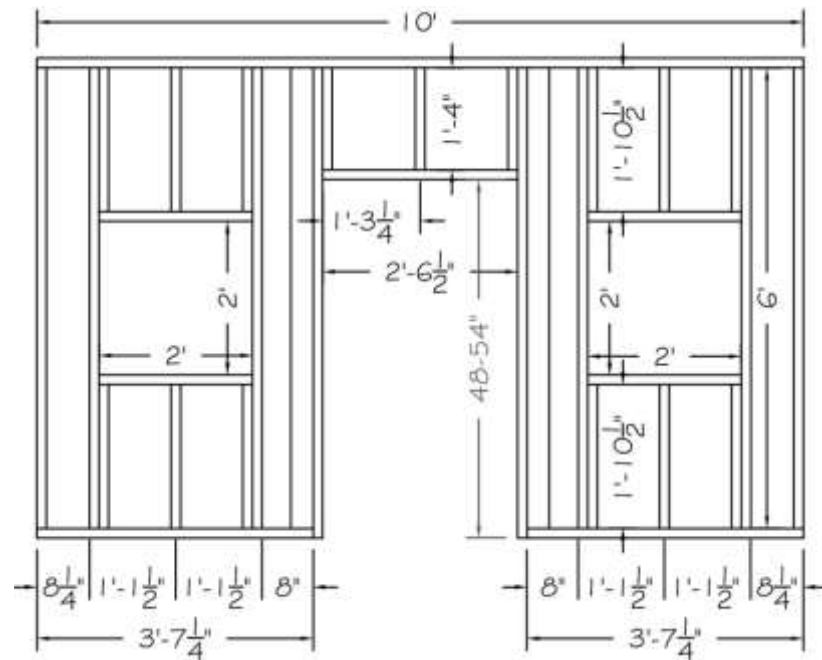

- 2) Assemble the entrance wall on the ground. Be careful when following the detail, there are many studs and it is easy to become confused. Refer to the full-color diagram below if you are having problems keeping the components in order.

This is the first 19 pages of our 63 page book available at the website

<http://plansforplayhouse.com>

Let me ask you a question...

# "Would You Like to Build a Playhouse for Your Children?"

Let me show you how to get started, with a step by step book, plans and 11 videos.



Read below to find out how to get all 11 of the videos, ebook and 10 playhouse plans.

**From: John Davidson - Residential Architectural Designer**, over 25 years of experience and I have drawn over 500 homes, garages, barns, cabins and **Playhouses**.

**Dear Friend,**

If you are interested in building a **Playhouse** in your backyard for your children, then this is going to be the most exciting message you will ever read. As I built a playhouse shed in my backyard, I documented every step of the way. Watch a sample video to see a sample of one of the 11 videos.

Check out this YouTube video

[http://www.youtube.com/watch?v=nlaR6AkFTQw&feature=channel\\_video\\_title&safety\\_mode=true&persist\\_safety\\_mode=1](http://www.youtube.com/watch?v=nlaR6AkFTQw&feature=channel_video_title&safety_mode=true&persist_safety_mode=1)

Original price ~~\$100.00~~ Limited time for only

**Introductory price \$7.00**



# "The 10 Playhouse Plans Plus the Bonus Videos and Book"



"The 8 x 10 Playhouse"



"The Garden Playhouse"



"The 10 x 12 Playhouse"



"The Saltbox Playhouse"



"The Adobe Playhouse"



"The Brick Playhouse"



"The Cottage Playhouse"



"The Country Cottage"



"The Kids Playhouse"



"The Salt Box Dormer"



"Bonus FREE Playhouse 64 page ebook"



"Bonus FREE Video training"

Now make sure that you follow these tips so that you can build a playhouse easily. Now grab the opportunity to get this amazing limited launching offer for only ~~\$100~~ **\$7.00** you can have it all. But after few weeks or more we will be changing it to much higher price. So what you are waiting for **Claim your Plans Now!**

# "With Step-By-Step Instructions & Easy To Follow Guides"

Now, we are getting to the wall structures. Some things to remember:

- 1) Always measure openings and cuts carefully!
- 2) Give yourself a small amount of rough opening space if you intend on purchasing windows and doors. We would recommend purchasing windows and doors prior to studying wall structures so you may measure accurate rough openings. This set of plans will assist you in including some general doors and windows, but you may feel free to purchase doors or windows at your discretion. **PLANS MAY NEED TO BE ALTERED!**
- 3) These plans are to be intended as a guide **ONLY!** Should you choose to alter these plans at any time, remember to adjust measurements accordingly!

Now, time to start on the walls.

1) Start by cutting the entrance wall as shown below. Cut lengths carefully and make sure edges are flush and corners are square.

2) Assemble the entrance wall on the ground. Be careful when following the details. Drive and study details as it is easy to become confused. Refer to the full-color diagram below if you are having problems keeping the components in order.

3) Start with the main outside frame. Assemble the base plate, soil plate, jamb plate and exterior studs.

4) Assemble one window structure at a time. Use a spirit square and level to ensure corners are straight vertically and horizontally. Repeat for the other side.

5) Layout the location of the window assemblies with a pencil and insert into the assembled entrance frame.

6) Assemble the door header assembly and locate in the main door location. These dimensions may change depending on if you decide to purchase or build the door! Measure carefully!

7) There is a 2" vertical header on either side of the door frame. You will need to follow these directions and make your own choice, if you purchased a door to install, you may neglect to install these headers.

Materials	
Description:	Qty:
2x4x8 Studs	6
2x4x8 1" Header	2
2x4x8 2" Header	2
2x4x8 1/2" Header Support	3
2x4x8 Window Sill & Header	4
2x4x8 1/2" Window Stud	12
2x4x8 2" Base Plate	2
2x4x8 1" Soil Plate	1
2x4x8 2" Nailer (optional)	2

**Dimensional Concepts**  
 12726 L. P.O. Box 1000, Can. #46 846 8870  
 12726 L. P.O. Box 1000, Can. #46 846 8870  
 Front Wall Assembly Item: J00 Approx. Price: \$13.00  
 Date: 01-Mar-2010 Item: 0 Vases: 6

To this point, you should have a roof structure that looks similar to the diagram below.

1) If you did the structural rafter completed the rest of the rafters should be a piece of cake. They are constructed very similar to the primary rafter. Refer to the plans below.

2) You will need 4 of these rafters if you need. You will notice you are getting to work on the secondary rafters. These are built after you are in. Simply layout the primary rafters similar to the diagram used for the diagonal rafters. Drive on secondary rafters that alternate rafters in place on the exterior gables and mark where your nails will need to be. Make sure the rafters align properly. Use a spirit square to ensure they are square.

3) You are essentially done with the roof structure. If you wish, you may add purlins for the secondary rafters and keep the rafters straight.

The second option: For a full look room, we would distribute from the main rafters and to cut the rest out of the rafters, but for the main system for the playhouse, make one not necessary. The roof sheathing will take care of any incident in the rafters and after you have the roof sheathing installed, you should be able to step on the roof without incident.

Make it a good design to show how purlins work, but we will not get into specifics, after what you have just completed, purlins are:

Normally, we would not recommend the method of spacing. Consider the roof sheathing as a cover and a purlin. The purlin will be used to support the roof sheathing. We suggest method for spacing using purlins, look in the options included with these plans.

Congratulations! This structural portion of the build is completed.

Materials	
Description:	Qty:
2x4x8 Diagonal Rafter	4

**Dimensional Concepts**  
 12726 L. P.O. Box 1000, Can. #46 846 8870  
 12726 L. P.O. Box 1000, Can. #46 846 8870  
 Diagonal Rafter Item: J00 Approx. Price: \$13.00  
 Date: 01-Mar-2010 Item: 0 Vases: 13

To this point, the playhouse is starting to look like a playhouse!

Now for the roof sheathing. We will first get the main portion and build the dormer sheathing to the main roof. Don't forget to put those little notches on the ends of the exterior rafters, you will need them to align the sheathing properly!

1) We will start with the main of the playhouse, since it is easiest. Simply cut sheets of 3/4 plywood (we would recommend cedar or oak for the roofing) as shown below.

You do NOT have to mirror the ends, but it offers a cleaner construction at the corners. This applies to ALL roof sheathing!

2) Front roof sheathing is much the same as the rear, you just need to account for the dormer. Thankfully, we have already done that!

3) The dormer sheathing isn't too bad either. Make sure you seal the seam with the front roof sheathing! You will want to cut out the very front cover and seal first!

Materials	
Description:	Qty:
4x8x3/4 Plywood Sheat	9

**Dimensional Concepts**  
 12726 L. P.O. Box 1000, Can. #46 846 8870  
 12726 L. P.O. Box 1000, Can. #46 846 8870  
 Roofing Item: J00 Approx. Price: \$15.00  
 Date: 01-Mar-2010 Item: 0 Vases: 15

# "All plans are available instantly with a link to download and print"

## Let me share with you the latest comments I have received in my inbox...

### "My Kids Playhouse Dream come True"

John,

My kids have been after me to build them a tree house / playhouse. I downloaded the plans for the country cottage. I'm amazed with the level of detail, it is better than any of the other plans I have seen out there. It is obvious that you spent many hours putting them together. The plans are straight forward and very readable, I should have no problem following them. I have bookmarked your site and will forward it to any friends who might be looking for plans as well.

By: **Pete**



### "Fantastic Playhouse Plans"

The plans look fantastic! The step by step instructions are very detailed. I can't wait to start building a playhouse for my children.

From: **Julie**



### "It is User Friendly Step by Step Playhouse Plan"

The graphics are really nice, with good dimensioning, and nice zoom-ins to see the details. I think what sets these plans apart from others is the way that the written and graphical instructions are intertwined, and that at the end of each step is a visual that shows what the finished product of that step will look like.

Thanks again and I look forward to building one of these playhouses for the kids soon.

By: **Norm**



### "I Plan to surprise my son and give him a Playhouse"

Seriously though, love the plans. They are incredible. I am having dreams of my young son and his friends camping out in his play house. It excites me and I am 34. I can't imagine how happy he'll be once I can get one of these put together for him. Thank you so much :)

By: **Michael**



**Let' see what the kids have to say!**

[http://www.youtube.com/watch?v=\\_d-ribv97k4](http://www.youtube.com/watch?v=_d-ribv97k4)

When all is said and done, you would always remember the playhouse that is well planned and built by you will last a long time. In the back yard and forever in your child's memories.

# The Best 100% Money-Back Guarantee Ever Offered

To Provide You With The Absolute Best Plans and Schematics For Building Any Playhouse...

I'm so confident in my playhouse plans and instructions that I'm willing to put all the risk on me. In fact, I've decided to do something that some people may consider outright crazy.

Here is the Deal: Try out our **10 playhouse plans** plus the **bonuses** for a **60 days**. And if you are not happy with our products for some unexplainable reason or don't like the plans. You can contact me anytime and in addition we have an online support center to help you. If not happy anytime within the 60 days for any reason, I can assure you the 100% money back guarantee and I will personally **refund all of your money**.

**Reserve Your Copy Right Now!**



**60 DAY MONEY BACK GUARANTEE**  
100% GUARANTEED

**My 60 Day  
100% money Back  
Guarantee**

If you find any reason whatsoever that the products are not worthwhile simply let me know within 60 day and I will personally refund all of your money - **NO QUESTIONS ASKED!**

Our trusted 3rd party retailer ClickBank's policy honor all requests within the period of time given. So you can be 100% assured that your purchase is **RISK-FREE**.

*John Davidson*

## Special Offer-Limited Bonus



**Bonus # 1**  
**EZ Playhouse Ebook**  
**(Price: \$25 - FREE for you)**

- ✓ Step by step instructions.
- ✓ Safety Precaution
- ✓ Immediate download
- ✓ Designed for both beginners and advanced woodworkers.

...and much more!





**Bonus # 2**  
**Video Tutorials**  
**(Price: \$15 - FREE for you)**

- ✓ Step by step instructions on how to build a playhouse.
- ✓ Safety measures.
- ✓ Good Quality Playhouse plans.



## Am I ready?

Always remember that a playhouse which is well planned and built by you would have to last longer. The most important aspect of this playhouse plans is **safety for your kids**. Your children who no doubt are extremely precious to you will be playing inside a great deal of the time and you don't want their safety compromised in any way I'm sure.

**Yes, Take Me To The Order Form Now**

**"It's So Easy Getting Started"**

To ensure that you follow these tips and build a playhouse easily, I've made getting started so quick and easy that anyone can do it. All you need to do is click on the **ADD TO CART** button below. You'll be taken to the 100% safe and secure ClickBank order form. Simply fill out your payment information and follow the prompts.

As soon as the payment has been accepted you'll be taken to our members area where you can instantly download the 10 playhouse plans plus the bonuses, the FREE Ebook for the step by step instructions in building a playhouse and the FREE series of video tutorials, where me and my boy build a playhouse in our yard. We talk you through every step of building the playhouse.

**Good luck in building your new Playhouse**



Specialized Design System LLC - Residential Architectural Designer

**P.S.** Always remember that your purchase is backed by my **60 Days 100% Money-Back Guarantee**. For any reason or if you don't like what you find inside, contact me anytime or we have an online support center to help with any concerns or issues that you may have. I'll refund all of your money - NO QUESTIONS ASKED!

**Download Your Copy Now!**

**P.P.S.** The playhouse plans cost over ~~\$100~~ each to have draw but for now we are offering everything plus bonuses for only **\$7.00** and you can get 10 of our high quality playhouse plans, plus the videos and ebook. But this promo is offered for just a limited period of time and we will increase the price without prior notice.

**Yes, Take Me To The Order Form Now!**



[Individual playhouse plans can be purchased separately](#)

**Yes, give Me Access To This  
Amazing Package And Bonuses  
Right Now...**

**I'm Ready To Have it all..**



- ✓ **10** Playhouse Plans in PDF Files.
- ✓ **FREE** Playhouse Ebook.
- ✓ **Plus video tutorials on how to build a Playhouse using the Playhouse Plans.**

**ADD TO CART**

